

CD-423M/423M-S/424M DPF-J3030/J5030 SERVICE MANUAL

© 1999-11/B51-5590-00 (K/K) 3037

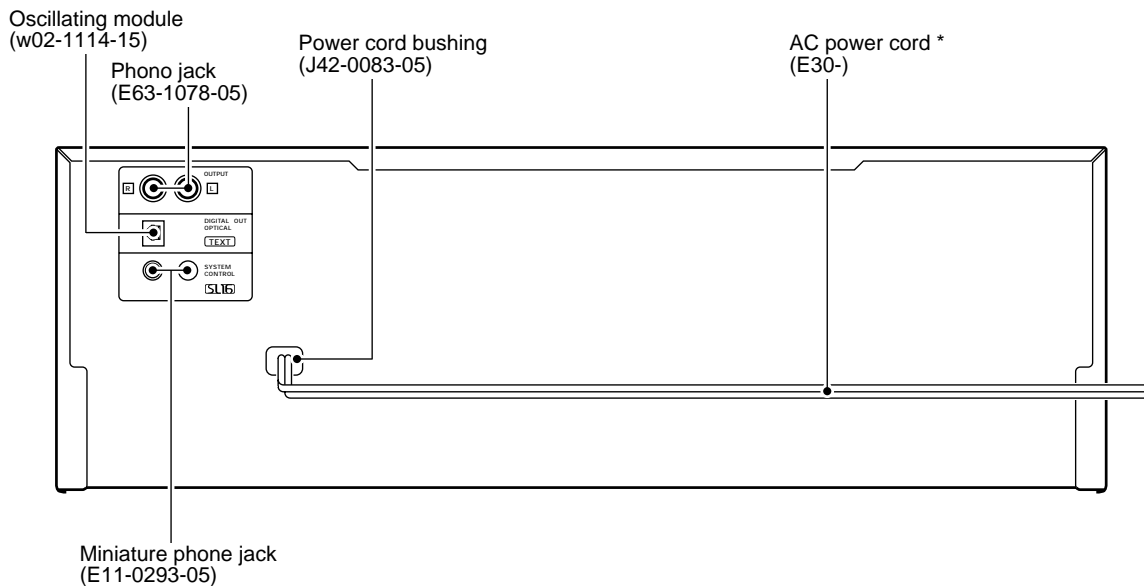
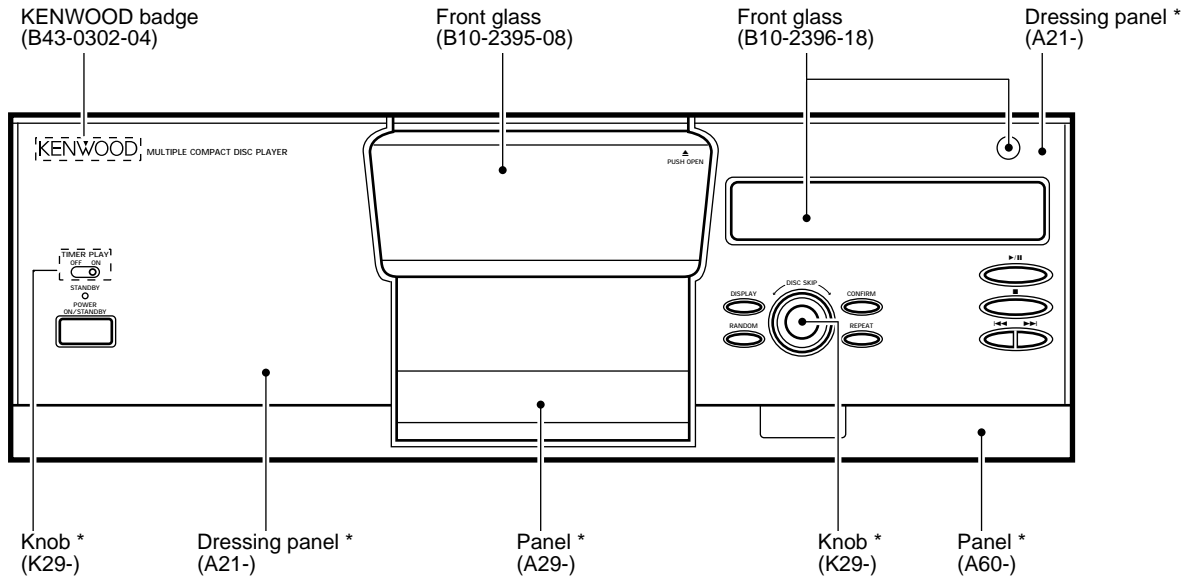

* Refer to parts list on page 17.

In compliance with Federal Regulations, following are reproduction of labels on, or inside the product relating to laser product safety.

KENWOOD-Crop. certifies this equipment conforms to DHHS Regulations No.21 CFR 1040. 10, Chapter 1, Subchapter J.

**DANGER : Laser radiation when open and interlock defeated.
AVOID DIRECT EXPOSURE TO BEAM.**

Refer to CD-223M/DPF-J3010 service manual (B51-5409-00) if require the following items in detail.
1) Mechanism operation description.
2) Disassembly for repair.



CD-423M/423M-S/424M/DPF-J3030/J5030

CONTENTS / ACCESSORIES / CAUTIONS

Contents

CONTENTS / ACCESSORIES / CAUTIONS.....	2	EXPLODED VIEW	15
CIRCUIT DESCRIPTION	3	PARTS LIST.....	17
ADJUSTMENT	8	PARTS DESCRIPTIONS	21
PC BOARD	9	SPECIFICATIONS	Back cover
SCHEMATIC DIAGRAM	11		

Accessories

Audio cord (1)
(E30-0505-05)



System control cord (1)
(E30-2816-05)

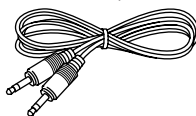

Batteries (R6/AA) (4)



Remote control units (2)
RC-KB2 : CD-424M/DPF-J5030 only
(A70-1326-05)

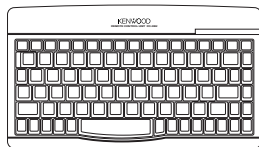

Battery cover (A09-1176-08)

RC-P0714
(A70-1336-05)

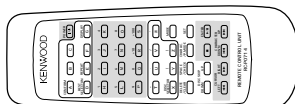

Battery cover (A09-0374-08)

Cautions

Operation to reset

The microcomputer may malfunction (impossibility to operate, erroneous display, etc.) when the connection cords are unplugged while power is ON or due to an external factor. In this case, execute the following method to reset the microcomputer and return it to normal condition.

Unplug the power cord from the power socket and plug the power cord into the socket again.

To reset the registered contents

The registered contents for title, music type, user file and best selection can be reset by the following procedure.

Unplug the power cord from the power socket, and while holding the  key depressed, plug the power cord into the socket again.

CIRCUIT DESCRIPTION

1. Main Microprocessor : uPD784214GF-533(IC6)

1-1 Microprocessor periphery block diagram

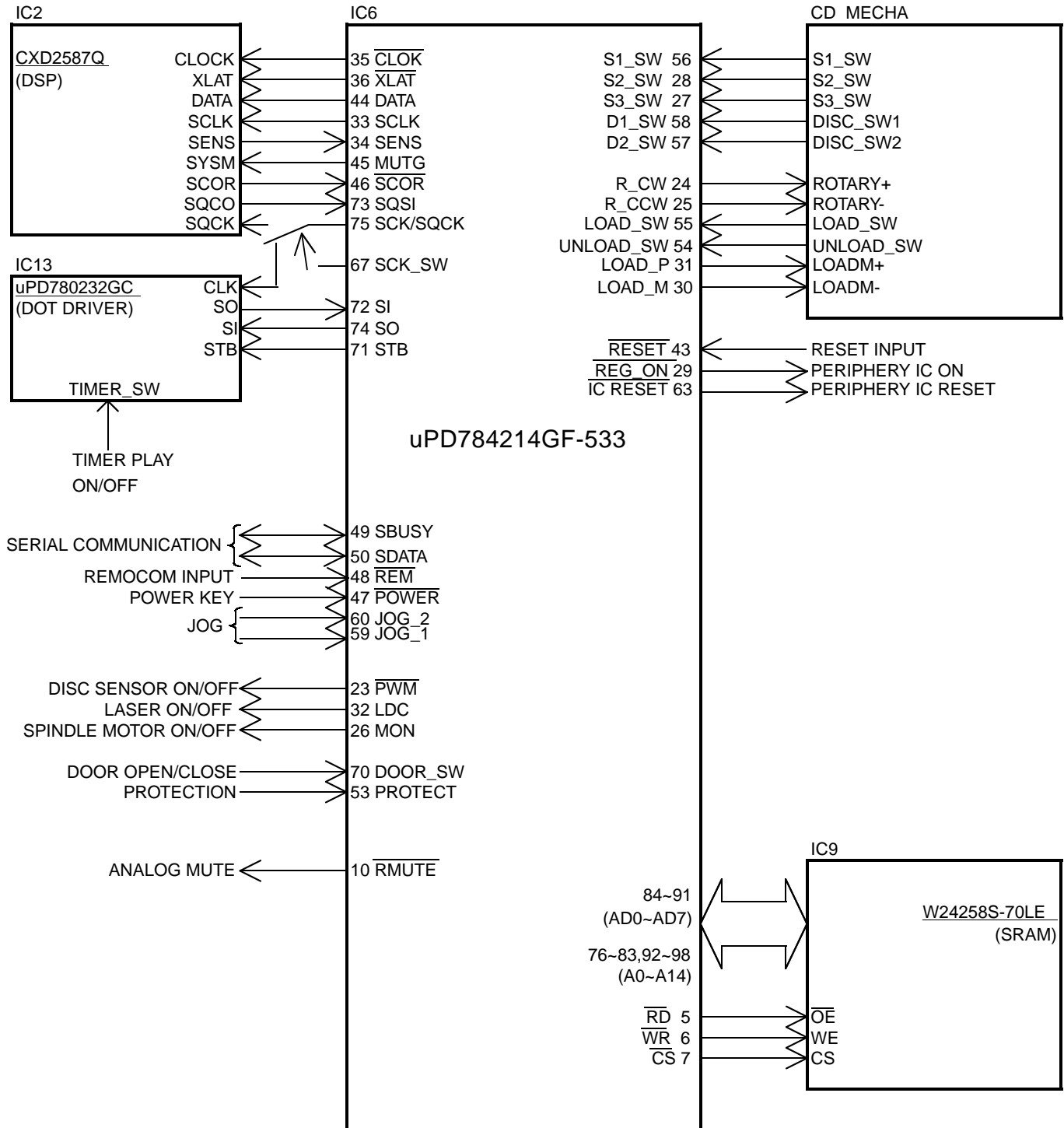

2. Key matrix

PORT		A/D 0(IC13,22pin)	A/D 1(IC13,21pin)
VOLTAGE	RESISTER		
2.9V	5.1K	RANDOM	REPEAT
2.0V	3K	DISPLAY	CONFIRM
1.2V	2K	STOP	DOWN
0.4V	SHORT	PLAY	UP

CD-423M/423M-S/424M/DPF-J3030/J5030

CIRCUIT DESCRIPTION

3. Microprocessor pin description (X32, IC6) :UPD784214GF-533

Pin No.	Pin Name	I/O	Description
1	A16(1M)	O	No used.
2	A17	O	No connection.
3	SCL	O	No connection.
4	SDA	I/O	No connection.
5	RD	O	SRAM read strobe.
6	WR	O	SRAM write strobe
7	CE	O	Chip selector
8	ASTB(CE)	O	No connection.
9	VDD	-	Power supply(+5V).
10	RMUTE	O	Analog muting signal output.
11	RWRR	O	No connection.
12	RWR	I	No connection.
13	RTRN	I	No connection.
14-21	L-D7-D0	O	No connection.
22	VPP	-	GND.
23	+5VPWM	O	Disc sensor ON/OFF. L:on
24	R-M-CW	O	Mechanism rotary motor(+). H:CCW
25	R-M-CCW	O	Mechanism rotary motor(-). H:CW
26	MON	O	Control port of poor focus works.
27	S3-SW	I	Mechanism address detector switch.
28	S2-SW	I	Mechanism address detector switch.
29	REG-ON	O	Power ON/OFF control.
30	LOADM- (IN2)	O	Loading motor(-) for main pickup.
31	LOADM+ (IN1)	O	Loading motor(+) for main pickup.
32	LDC	O	Laser on/off. L: Laser diode on.
33	SCLK	O	Sens serial data read clock.
34	SENS	I	SENS signal input.
35	CLK	O	Serial data clock.
36	XLAT	O	CXD2587Q latch. H → L:latch
37	VDD	-	Power supply(+5V).
38,39	X1,2	-	Main system clock(12.5MHz).
40	VSS	-	GND.
41	XT2	-	No connection.
42	XT1	I	GND.
43	RESET	I	System reset signal input.
44	DATA	O	Serial data output.
45	MUTEG(SYSTEM)	O	System muting control output.
46	SCOR	I	Sub code synchro detection.
47	POWER	I	Power key input terminal.
48	REM	I	Remote control signal input.
49	SBUSY	I/O	Serial busy signal I/O.
50	SDATA	I/O	Serial data signal I/O.
51	AVDD	-	Power supply(+5V).
52	AVREF	-	A/D reference power supply.
53	PROTECT	I	Detection signal input of protection.
54	UNLOAD-SW1	I	Unloading switch for main pickup.
55	LOAD-SW1	I	Loading switch for main pickup.
56	S1-SW	I	Mechanism address detector switch.
57	DISC-SW2	I	Disc2 sensor input..
58	DISC-SW	I	Disc sensor.
59	JOG2	I	Encoder signal input.
60	JOG1	I	Encoder signal input.

CIRCUIT DESCRIPTION

Pin No.	Pin Name	I/O	Description
61	AVSS	-	GND.
62	LED	O	STANDBY LED control terminal.
63	ICRESET	O	IC reset.
64	AVREF1	-	D/A reference power supply.
65	RXD-232C	I	No connection.
66	TXD-232C	O	No connection.
67	SQCK/SCK-SW	O	SQCK,SCK(DOT/DSP clock) selector. L:DSP.
68	RXD-R	I	No connection.
69	TXD-R	O	No connection.
70	DOOR-SW	I	Door open/close detector switch.
71	STB1	O	Strobe signal output to dot driver.
72	S1	O	Data output to dot driver.
73	SQS1	I	Sub code read data input.
74	S0	I	Data input from dot driver.
75	SCK/SQCK	O	Dot driver/sub code read clock.
76-83	A0~A7	O	Address output to SRAM.
84-91	D0-7	I/O	SRAM data bus.
92-98	A8~A14	O	Address output to SRAM.
99	A15(1M)	O	No used.
100	VSS	-	GND.

4. FL Microprocessor : UPD 780232GC-012 (X32-IC13)

Pin description

Pin No.	Pin Name	I/O	Description
1	VDD	-	Power supply(+5V)
2	VSS	-	GND.
3,4	X1,2	-	Main system clock.(5MHz).
5	VPP	-	GND.
6	RESET	I	System reset input.
7	SCK	I	Serial clock.
8	SI	I	Data input.
9	SO	O	Data output.
10	POW-P	I/O	Timer sw on input.
11	LED-A	O	No used.
12	LED-B	O	No used.
13	STANDBY	O	No used.
14	NC	-	No used.
15	STB	I	Strobe signal input.
16	REM	I	No used.
17	NC	-	No used.
18	AVSS	-	GND.
19,20	A/D3,A/D2	-	GND.
21,22	A/D1,A/D0	I	Key return signal input(1,0).
23	VSS	-	GND.
24,25	AVDD/VDD	-	Power supply(+5V)
26	NC	-	No connection.
27-43	P1-P17	O	FL control output. 1G(▶■),2G-16G(P1to P17).
44-58	P21-35	O	FL control output. 2G-16G(P21to P35).
59	VDD	-	Power supply(+5V)
60	VLOAD	-	Negative power supply(-37.5V)
61-63	P18-P20	O	FL control output. 2G-16G(P18 to P20).
64	NC	-	No connection.
65-72	1G-8G	O	FL control output.1G-8G.
73-80	9G-16G	O	FL control output.9G-16G.

CIRCUIT DESCRIPTION

5. Test mode

INPUT KEY	PROCEDURE	DISPLAY
Insert the AC plug to the wall outlet with pressing the SKIP-DOWN key.	INITIAL CONDITION <ul style="list-style-type: none"> • Disc No.1 moves to the center. • Clear the memory of the SRAM. • Door opens. • Set the switch of TIMER ON PLAY to ON. • Set the switch of SYSTEM CONTROL to XS8. 	MECHA. INITIAL INITIAL OK!! INITIAL NG TIMER, NG SER, NG
Insert the AC plug to the wall outlet with pressing the REPEAT key	CIRCUIT ADJUSTMENT <ul style="list-style-type: none"> • Open the door and load the disc to the Disc No.1. • Close the door. The unit changes to test mode 05 . after clamping the disc 	TEST ON
PLAY/PAUSE	Change the mode 05(tracking-on) and 03(tracking-off) alternately . by the PLAY key	05 XX:XX 03 XX:XX
STOP UP DOWN RANDOM	Stop the function. The pickup travels outwards. The pickup travels inwards. Shows the result of self-adjustment. 07 EF/FB 08 TG/FG 09 FE/RF 10 TE/VC Mode changes alternately by the RANDOM key.	00 MOTOR FORWARD MOTOR REVERSE 07 XXX:XXX 08 XXX:XXX 09 XXX:XXX 10 XXX:XXX NG: blinking
REPEAT	Playback PGM signal of the Track No.7,13,23,30,34 and 41 in the order. And release the test mode.	
CONFIRM (TIMER PLAY SW)	Release the test mode. Check the switch position.	TIMER ON , TIMER OFF
Insert the AC plug to the wall outlet with pressing the UP key.	CHECK THE MECHANISM JAMMING. Clamp the Disc No1,2,100,50,200 and 199 in the order.	
Insert the AC plug to the wall outlet with pressing the RANDOM key.	THE MECHANISM TEST MODE. Display shows Niagara until pressing any keys.	
PLAY/PAUSE	Change the mode 05(tracking-on) and 03(tracking-off) alternately by the PLAY key.	05 XX:XX 03X:XX
STOP	Stop the function. Shows the result of self-adjustment. 07 EF/FB 08 TG/FG 09 FE/RF 10 TE/VC Mode changes alternately by the STOP key.	07 XXX:XXX 08 XXX:XXX 09 XXX:XXX 10 XXX:XXX NG: blinking
UP	Arm Motor Load operation.	MOTOR LOAD
DOWN	Arm Motor Unload operation.	MOTOR UNLOAD
RANDOM	Rotary Motor Clockwise turning.	MOTOR CW
DISPLAY	Rotary Motor Counterclockwise turning.	MOTOR CCW
REPEAT	Playback PGM signal of the Track No.1,23 and 41 in the order.And release the test mode.	
CONFIRM (TIMER PLAY SW)	Release the test mode. Check the switch position.	TIMER ON , TIMER OFF

CD-423M/423M-S/424M/DPF-J3030/J5030

CIRCUIT DESCRIPTION

6. Error code

DISPLAY	ERROR CONTENTS
MECHA ERROR 01	No input of S3. The original position error of Disc Number.
MECHA ERROR 02	No input of S2. The turning direction error to counterclockwise
MECHA ERROR 03	No input of S1. The turning direction error to clockwise
MECHA ERROR 04	No input of main load sw.
MECHA ERROR 05	No input of main unload sw.
MECHA ERROR 08	No backed up(AC power cord has disconnected).

S1-3: Mechanism address detector switch.

There are load and unload switches in the main pickup.

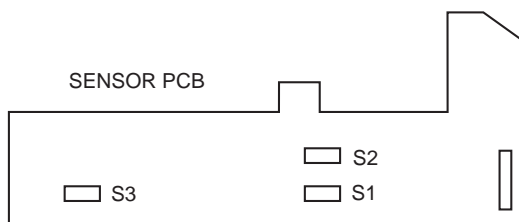

S1 DISC 1~9
S2 DISC 10~99
S3 DISC 100~200

ADJUSTMENT

No.	ITEM	INPUT SETTING	OUTPUT SETTING	PLAYER SETTING	ALIGNMENT POINT	ALIGN FOR	FIG.
1. With pressing the REPEAT KEY, turn the power on to enter the test mode. 2. Set the Test disc to Disc NO. 1. 3. Close the door.							
1	FOCUS ERROR BIAS	Test disc Type4 /KTD-02	Connect an oscilloscope as follows. CH1:RF (CN2-1)	Press the PLAY /PAUSE key . Confirm that the display is "05".	FE BIAS VR1	Optimum eye pattern	(d)
2	LASER CURRENT CHECK	Test disc Type4	Connect the DC voltmeter to LASER CURRENT CHECK LAND on X32.	Press the PLAY /PAUSE key to check that the display is 03 or 05.	-	0.5±0.2V	

Note:

Type 4 disc :SONY YEDS-18 Test Disc or equivalent.

LPF : Around 47kΩ + 390 pF or so.

FIG. (d)

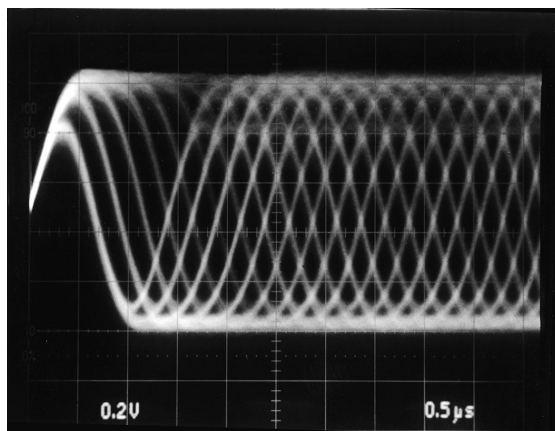

RF signal

- RF signal in test mode (PLAY).
- Perform the tangential and focusing offset are focused into one point on the display. The crossing points above and below the center shall also be looked clearly. (FE BIAS)

PC BOARD (Component side view)

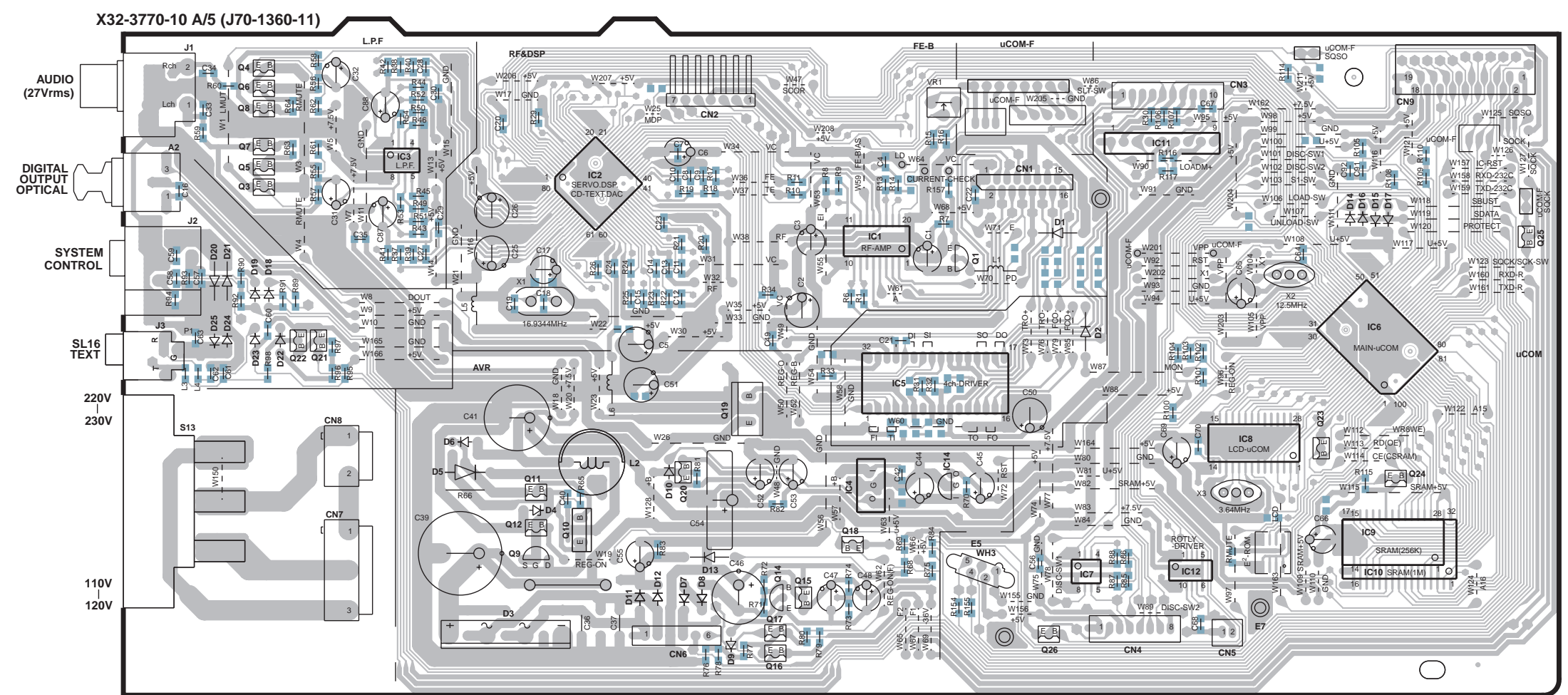
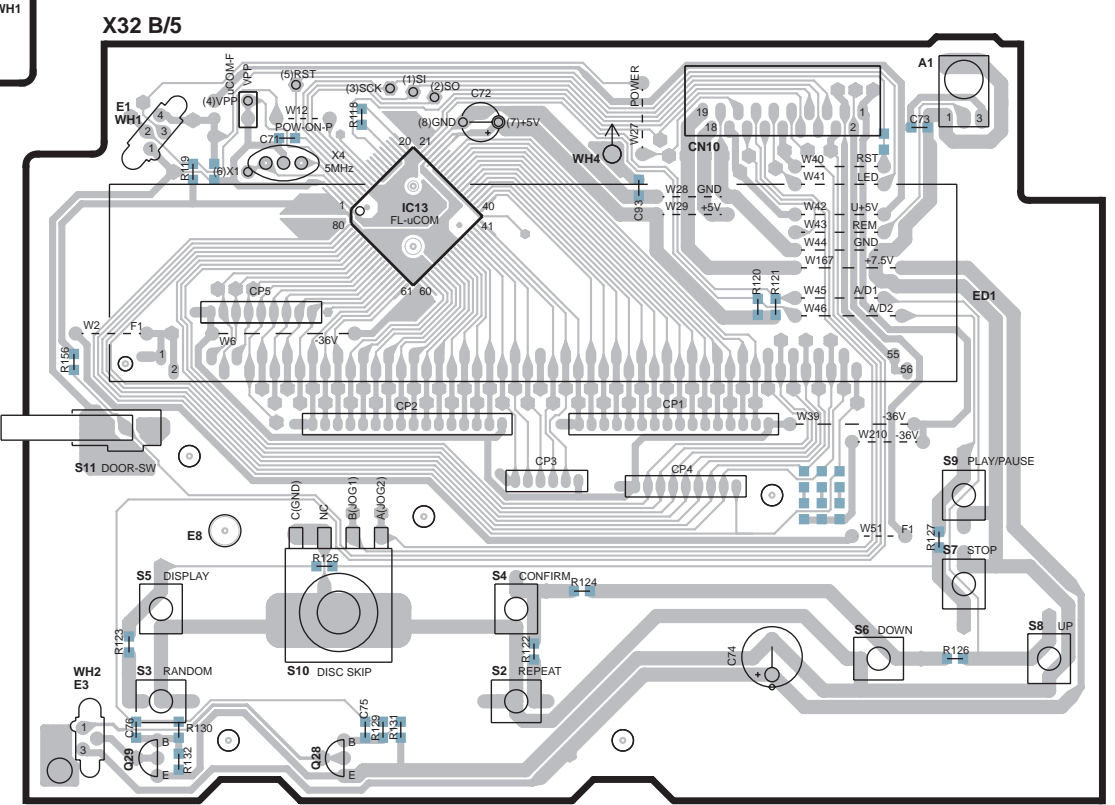
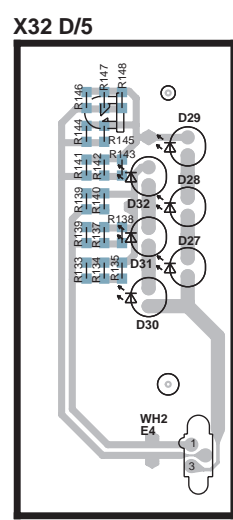
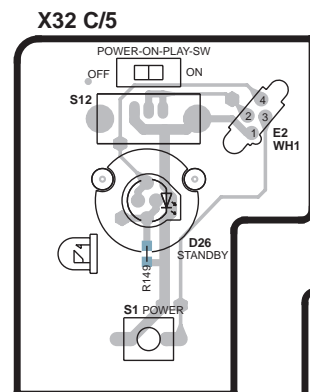
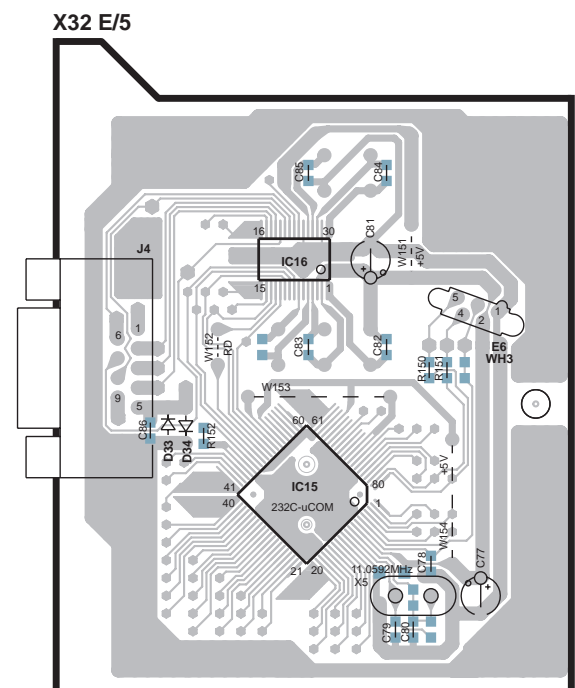

Refer to the schematic diagram for the value of resistors and capacitors.

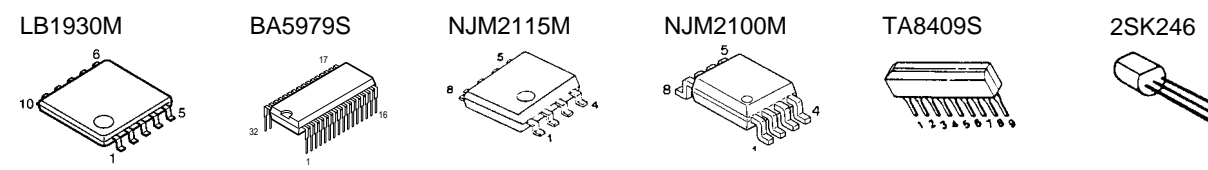
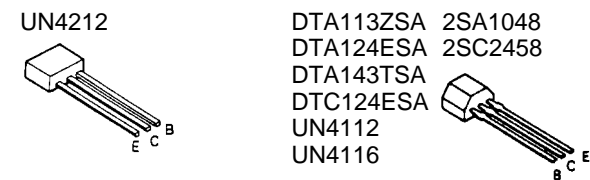
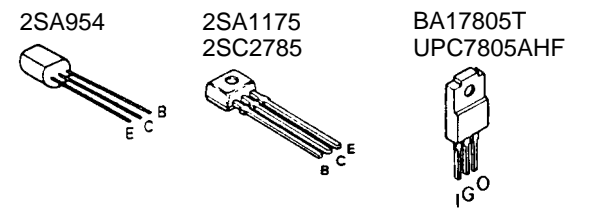
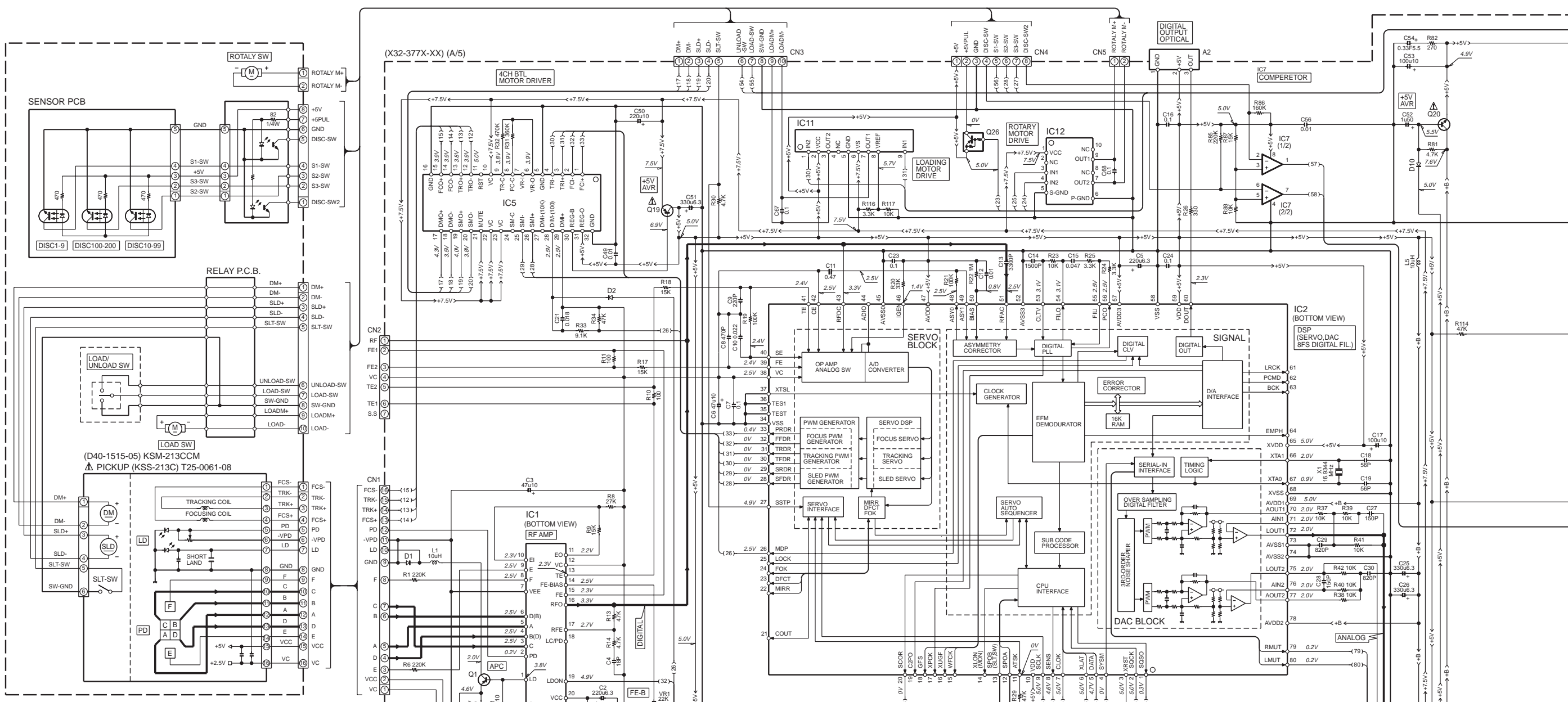

- IC1 : CXA1821M
- IC2 : CXD2587Q*
- IC3 : NJM2115M
- IC4 : UPC7805AHF or BA17805T
- IC5 : BA5979S
- IC6 : UPD784214GF533
- IC7 : NJM2100M
- IC8 : W24258S-70LE or CV62258LL-70
- IC9 : TA8409S
- IC10 : LB1930M
- IC11 : UPD780232GCO12
- IC12 : PST993D-T
- Q1,14 : 2SA954(L,K)
- Q3,4,12,24,25 : DTC124ESA or UN4212
- Q5,6 : DTA143TSA or UN4116
- Q7,8,16,17 : 2SD1450(S,T)
- Q9 : 2SK246(Y)
- Q10 : 2SB1165(R,S)
- Q11,20 : 2SC2785(F,E) or 2SC2458(Y,GR)
- Q15 : 2SA1175(F,E) or 2SA1048(Y,GR)
- Q18,26 : DTA113ZSA or UN4119
- Q19 : 2SB1640 or 2SB1417(Q,P)
- Q23 : DTA124ESA or UN4112
- D1,2,6,10,13-21 : 1SS133 or HSS104
- D3 : D3SBA20F03 or RBV-402LFA
- D4 : MTZJ7.5(B) or RD7.5JS(B2)
- D5 : DLM10C
- D7,8,11,12 : S5688B(TPB5)
- D9 : MTZJ11(B) or RD11ES(B2)
- D26 : B30-2493-05
- ED1 : 16-MT-66GNK
- A1 : W02-2561-05
- A2 : W02-1114-15

CD-423M/423M-S/424M (X32-3770-10)				
DESTINATION	COUNTRY	ABB.	UNIT No.	S13 W150
U.S.A.	K		0-10	NO YES
CANADA	P			

DPF-J3030 (X32-3770-10)				
DESTINATION	COUNTRY	ABB.	UNIT No.	S13 W150
U.K.	T		0-10	NO YES
EUROPE	E			

DPF-J5030 (X32-3772-91)				
DESTINATION	COUNTRY	ABB.	UNIT No.	S13 W150
PX	Y		2-91	YES NO

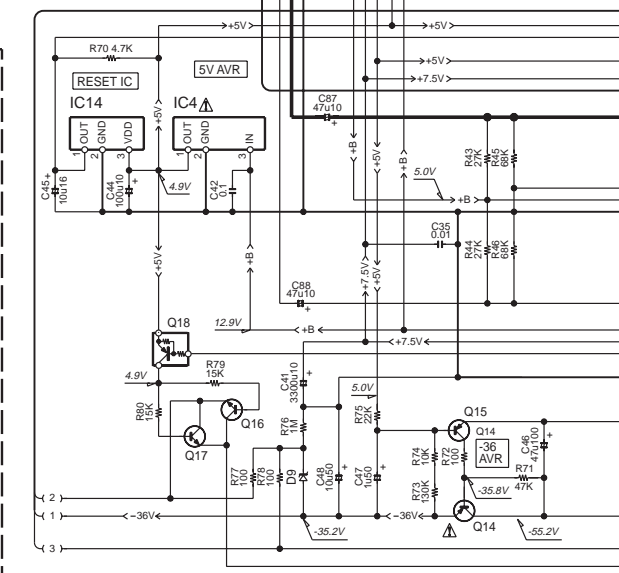
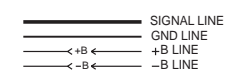

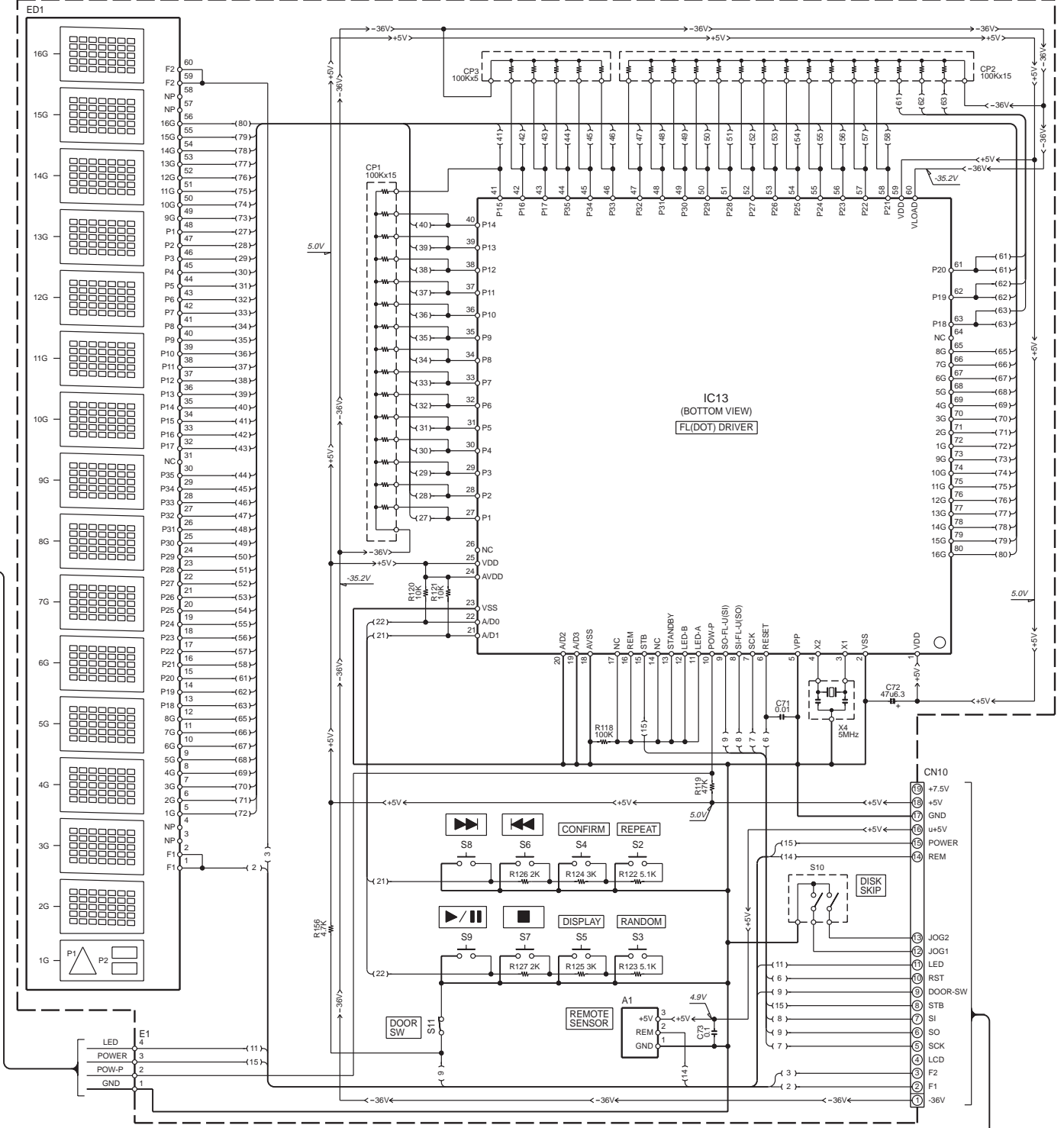
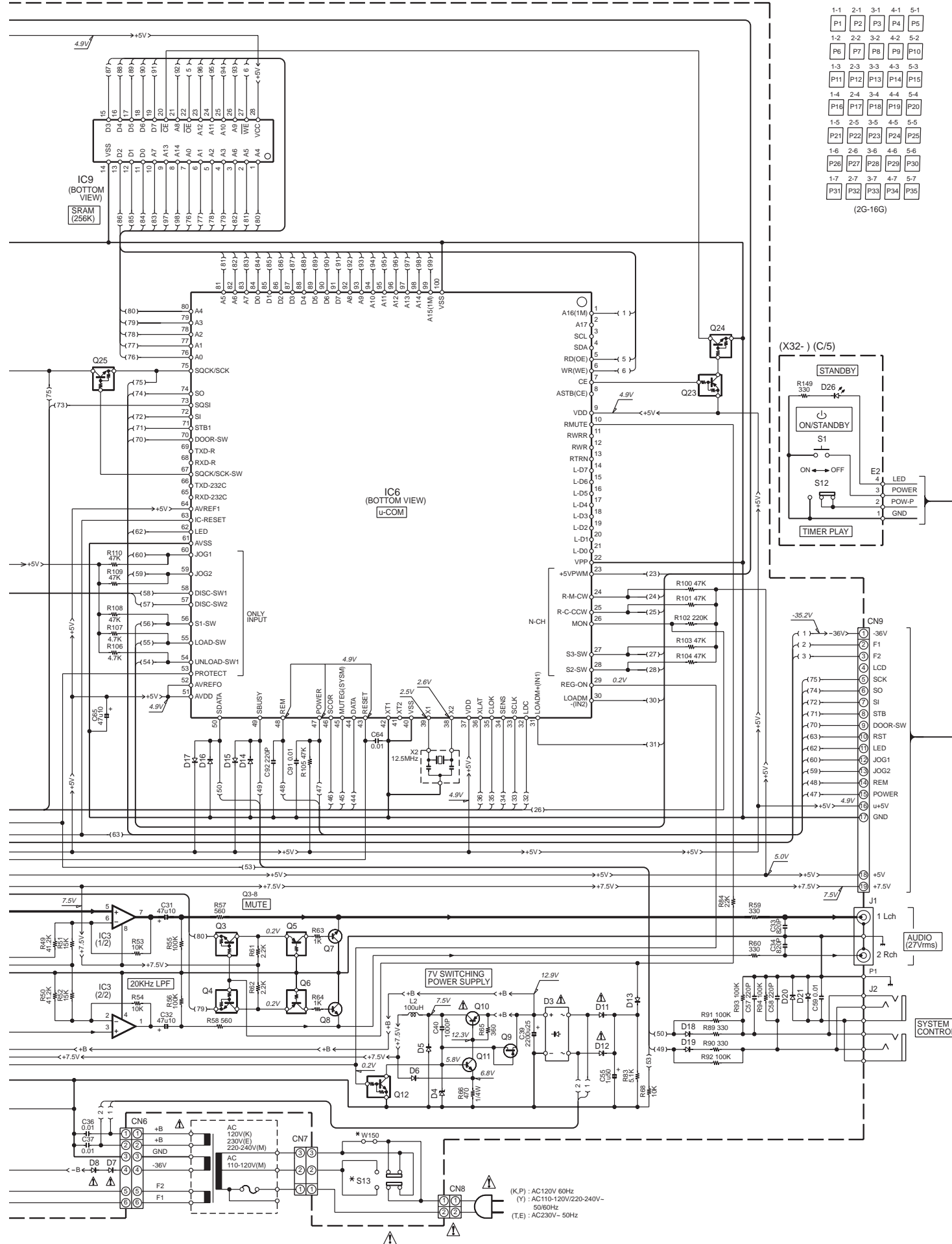

CD-423M/423M-S/424M (K,P)
DPF-J3030 (T,E)
DPF-J5030 (Y)

CAUTION: For continued safety, replace safety critical components only with manufacturer's recommended parts (refer to parts list). Δ indicates safety critical components. For continued protection against risk of fire, replace only with same type and rating fuse(s). To reduce the risk of electric shock, leakage-current or resistance measurements shall be carried out (exposed parts are acceptably insulated from the supply circuit) before the appliance is returned to the customer.

The DC voltage is an actual reading measured with a high impedance type voltmeter with no signal input. The measurement value may vary depending on the measuring instruments used or on the product.

CD-423M/423M-S/424M/DPF-J3030/J5030

EXPLODED VIEW(MECHANISM)

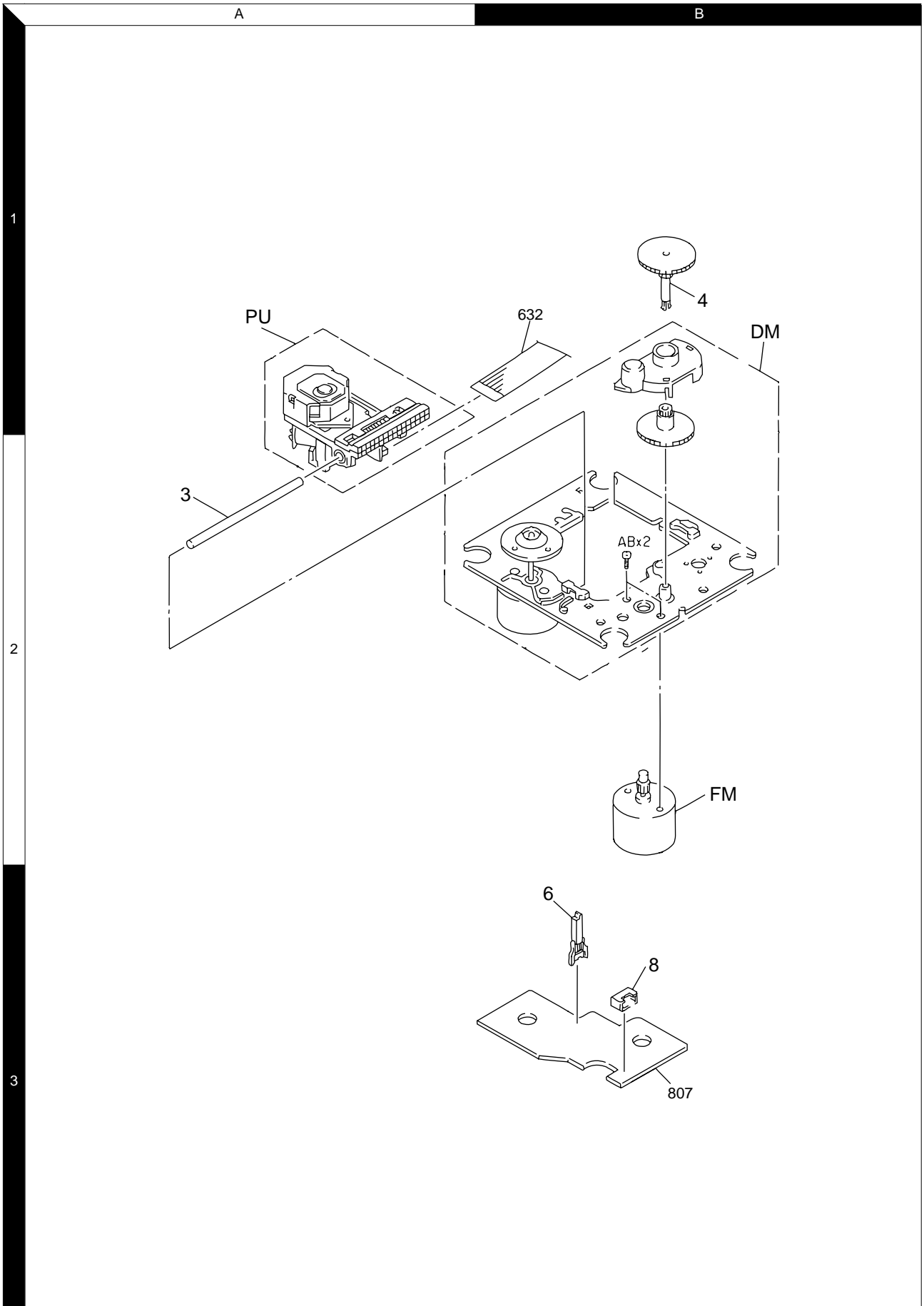

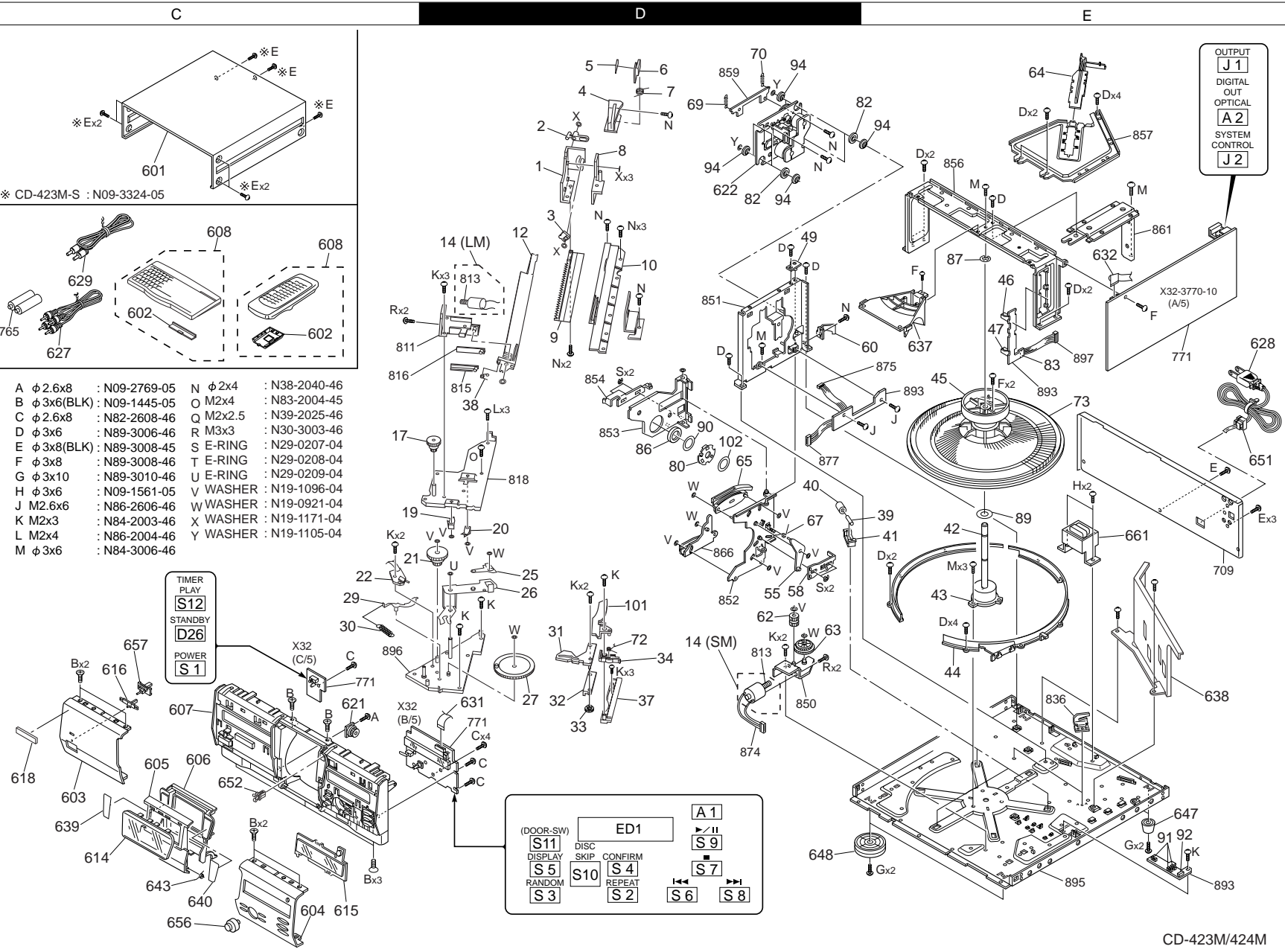
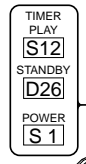
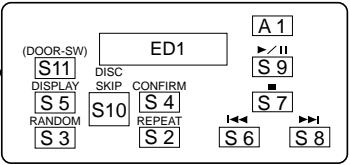
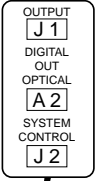

- | | |
|---------------------------------|----------------------------|
| A ϕ 2.6x8 : N09-2769-05 | N ϕ 2x4 : N38-2040-46 |
| B ϕ 3x6(BLK) : N09-1445-05 | O M2x4 : N83-2004-45 |
| C ϕ 2.6x8 : N82-2608-46 | Q M2x2.5 : N39-2025-46 |
| D ϕ 3x6 : N89-3006-46 | R M3x3 : N30-3003-46 |
| E ϕ 3x8(BLK) : N89-3008-45 | S E-RING : N29-0207-04 |
| F ϕ 3x8 : N89-3008-46 | T E-RING : N29-0208-04 |
| G ϕ 3x10 : N89-3010-46 | U E-RING : N29-0209-04 |
| H ϕ 3x6 : N09-1561-05 | V WASHER : N19-1096-04 |
| J M2.6x6 : N86-2606-46 | W WASHER : N19-0921-04 |
| K M2x3 : N84-2003-46 | X WASHER : N19-1171-04 |
| L M2x4 : N86-2004-46 | Y WASHER : N19-1105-04 |
| M ϕ 3x6 : N84-3006-46 | |

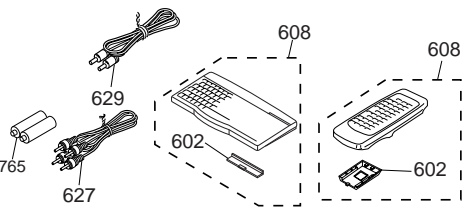
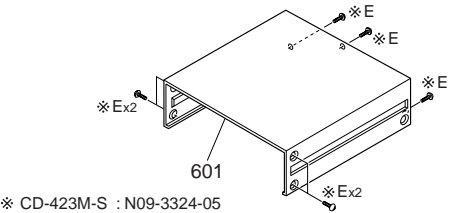

* CD-423M-S : N09-3324-05

CD-423M/424M

* New Parts

Parts without **Parts No.** are not supplied.
Les articles non mentionnes dans le **Parts No.** ne sont pas fournis.
Teile ohne **Parts No.** werden nicht geliefert.

1

Ref. No	Add-ress	New Parts	Parts No.	Description	Desti-nation	Re-marks
CD-423M/423M-S/424M/DPF-J3030/J5030						
601	1C	*	A01-3723-08	METALLIC CABINET	E1K2P2	
601	1C	*	A01-3723-08	METALLIC CABINET	KP1T1	
601	1C	*	A01-3723-08	METALLIC CABINET	Y1	
601	1C	*	A01-3724-08	METALLIC CABINET	K1	
602	2C		A09-0374-08	BATTERY COVER		
602	2C	*	A09-1176-08	BATTERY COVER (KEYBOARD)	K2P2Y1	
603	2C	*	A21-3788-08	DRESSING PANEL (L)BLK	KP1	
603	2C	*	A21-3789-08	DRESSING PANEL (L)SILVER	K1	
603	2C	*	A21-3790-08	DRESSING PANEL (L)BLK	T1E1	
603	2C	*	A21-3791-08	DRESSING PANEL (L)BLK	K2P2	
603	2C	*	A21-3793-08	DRESSING PANEL (L)BLK	Y1	
604	2C	*	A21-3786-08	DRESSING PANEL (R)BLK	E1K2P2	
604	2C	*	A21-3786-08	DRESSING PANEL (R)BLK	KP1T1	
604	2C	*	A21-3786-08	DRESSING PANEL (R)BLK	Y1	
604	2C	*	A21-3787-08	DRESSING PANEL (R)SILVER	K1	
605	2C	*	A29-1079-08	PANEL (CENTER)	K1	
605	2C	*	A29-1087-08	PANEL (CENTER)	E1K2P2	
605	2C	*	A29-1087-08	PANEL (CENTER)	KP1T1	
605	2C	*	A29-1087-08	PANEL (CENTER)	Y1	
606	2C		A46-0310-08	REAR COVER	E1K2P2	
606	2C		A46-0310-08	REAR COVER	KP1T1	
606	2C	*	A46-0330-08	REAR COVER	Y1	
607	2C	*	A60-1732-08	PANEL	K1	
607	2C	*	A60-1732-08	PANEL	E1K2P2	
607	2C	*	A60-1732-08	PANEL	KP1T1	
607	2C	*	A60-1732-08	PANEL	Y1	
607	2C	*	A60-1733-08	PANEL	K1	
608	1C	*	A70-1326-05	REMOTE CONTROL ASSY (RC-KB2)	K2P2Y1	
608	1C	*	A70-1336-08	REMOTE CONTROL ASSY (RC-P0714)		
614	2C		B10-2395-08	FRONT GLASS		
615	2C		B10-2396-18	FRONT GLASS		
616	2C		B12-0337-08	INDICATOR		
618	2C		B43-0302-04	KENWOOD BADGE		
-	-		B20-0623-18	SCALE		
-	-		B46-0310-03	WARRANTY CARD	T1E1	
-	-		B46-0328-03	WARRANTY CARD	KK1K2	
-	-		B46-0328-03	WARRANTY CARD	Y1	
-	-		B46-0346-00	QUESTIONNAIRE CARD	KK1K2	
-	-		B46-0347-03	WARRANTY CARD	P1P2	
-	-		B58-0513-04	CAUTION CARD (PRESET220-240)	Y1	
-	-		B58-0964-13	CAUTION CARD (UL)	KK1K2	
-	-		B58-0964-13	CAUTION CARD (UL)	Y1	
-	-		B58-0965-13	CAUTION CARD (T.XtypePL)	T1	
-	-		B58-0966-13	CAUTION CARD (ELMtypePL)	E1	
-	-	*	B58-0967-03	CAUTION CARD (PtypePL)	P1P2	
-	-		B59-1104-00	SERVICE DIRECTORY	Y1	
-	-	*	B60-4446-08	INSTRUCTION MANUAL (EN)	KK1P1	
-	-	*	B60-4446-08	INSTRUCTION MANUAL (EN)	T1	
-	-	*	B60-4447-08	INSTRUCTION MANUAL (FR)	P1E1	
-	-	*	B60-4448-08	INSTRUCTION MANUAL (IT/ES)	E1	
-	-	*	B60-4449-08	INSTRUCTION MANUAL (GE/NE)	E1	
-	-	*	B60-4450-08	INSTRUCTION MANUAL (EN)	K2P2Y1	
-	-	*	B60-4451-08	INSTRUCTION MANUAL (FR)	P2	

L : Scandinavia K : USA P : Canada R : Mexico C : China I : Malaysia
Y : PX(Far East,Hawaii) T : England E : Europe G : Germany V : China(Shanghai)
Y : AAFES(Europe) X : Australia Q : Russia H : Korea M : Other Areas Δ indicates safety critical components.

* New Parts

Parts without **Parts No.** are not supplied.
Les articles non mentionnes dans le **Parts No.** ne sont pas fournis.
Teile ohne **Parts No.** werden nicht geliefert.

2

Ref. No	Add-ress	New Parts	Parts No.	Description	Desti-nation	Re-marks
621	2C		D39-0335-18	DAMPER		
622	1D		D40-1515-05	MECHA ASSY(TRVERSE)		
627	1C		E30-0505-05	AUDIO CORD		
628	1E		E30-2788-05	AC POWER CORD	E1	
628	1E		E30-2789-05	AC POWER CORD	Y1	
628	1E		E30-2791-05	AC POWER CORD	T1	
628	1E		E30-2883-05	AC POWER CORD	KK1P1	
628	1E		E30-2883-05	AC POWER CORD		
629	1C		E30-2816-05	AC POWER CORD WITH PLUG	K2P2	
631	2D	*	E35-2446-08	FLAT CABLE (19P)		
632	1E	*	E35-2459-08	FLAT CABLE (16P)		
637	1E		F07-1613-08	COVER		
638	2E	*	F07-1691-08	COVER		
639	2C	*	F19-1093-08	BLIND PLATE	K1	
640	2C	*	F19-1094-08	BLIND PLATE	K1	
643	2C		G01-4026-18	TORSION COIL SPRING		
-	-		H10-7397-18	POLYSTYRENE FOAMED FIXTURE		
-	-		H10-7398-18	POLYSTYRENE FOAMED FIXTURE		
-	-		H12-2401-08	PACKING FIXTURE	KK1P1	
-	-		H12-2401-08	PACKING FIXTURE	T1E1	
-	-	*	H12-3410-08	PACKING FIXTURE	K2P2Y1	
-	-		H21-0353-18	PROTECTION SHEET		
-	-		H25-0232-04	PROTECTION BAG (235X350X0.03)	E1K2P2	
-	-		H25-0232-04	PROTECTION BAG (235X350X0.03)	KK1P1	
-	-		H25-0232-04	PROTECTION BAG (235X350X0.03)	Y1	
-	-		H25-0651-04	PROTECTION BAG (0232 PRINT)	T1	
-	-		H25-0692-04	PROTECTION BAG		
-	-	*	H50-3533-08	ITEM CARTON CASE	KP1	
-	-	*	H50-3534-08	ITEM CARTON CASE	K1	
-	-	*	H50-3535-08	ITEM CARTON CASE	T1E1	
-	-	*	H50-3536-08	ITEM CARTON CASE	K2P2	
-	-	*	H50-3538-08	ITEM CARTON CASE	Y1	
647	2E	*	J02-1461-08	FOOT (REAR)		
648	2D	*	J02-1474-08	FOOT (FRONT)		
651	1E		J42-0083-05	POWER CORD BUSHING		
652	2C		J52-0039-05	PUSH LATCH		
656	2C		K29-6824-18	KNOB	E1K2P2	
656	2C		K29-6824-18	KNOB	KP1T1	
656	2C		K29-6824-18	KNOB	Y1	
656	2C		K29-6884-18	KNOB	K1	
657	2C		K29-6885-38	KNOB	E1K2P2	
657	2C		K29-6885-38	KNOB	KP1T1	
657	2C		K29-6885-38	KNOB	Y1	
657	2C	*	K29-7671-08	KNOB	K1	
661	2E	*	L07-2844-08	POWER TRANSFORMER	KK1P1	
661	2E	*	L07-2844-08	POWER TRANSFORMER	K2P2	
661	2E	*	L07-2845-08	POWER TRANSFORMER	Y1	
661	2E	*	L07-2846-08	POWER TRANSFORMER	T1E1	
CD PLAYER UNIT (X32-3770-10)						
D26			B30-2493-05	LED(RED,P=5MM)		
C1			CE04KW1A101M	ELECTRO 100UF	10WV	
C2			CE04KW0J221M	ELECTRO 220UF	6.3WV	

L : Scandinavia K : USA P : Canada R : Mexico C : China I : Malaysia
Y : PX(Far East,Hawaii) T : England E : Europe G : Germany V : China(Shanghai)
Y : AAFES(Europe) X : Australia Q : Russia H : Korea M : Other Areas Δ indicates safety critical components.

PARTS LIST

CD-423M/423M-S/424M/DPF-J3030/J5030

* New Parts
 Parts without **Parts No.** are not supplied.
 Les articles non mentionnes dans le **Parts No.** ne sont pas fournis.
 Teile ohne **Parts No.** werden nicht geliefert.

3

Ref. No	Add-ress	New Parts	Parts No.	Description	Desti-nation	Re-marks
C3			CE04KW1A470M	ELECTRO	47UF	10WV
C4			CC73FCH1H180J	CHIP C	18PF	J
C5			CE04KW0J221M	ELECTRO	220UF	6.3WV
C6			CE04KW1A470M	ELECTRO	47UF	10WV
C7			CK73FB1E104K	CHIP C	0.10UF	K
C8			CC73FSL1H471J	CHIP C	470PF	J
C9			CC73FSL1H221J	CHIP C	220PF	J
C10			CK73FB1H223K	CHIP C	0.022UF	K
C11			CK73FB1C474K	CHIP C	0.47UF	K
C12			CK73FB1H103K	CHIP C	0.010UF	K
C13			CK73FB1H332K	CHIP C	3300PF	K
C14			CK73FB1H152K	CHIP C	1500PF	K
C15			CK73FB1H473K	CHIP C	0.047UF	K
C16			CK73FB1E104K	CHIP C	0.10UF	K
C17			CE04KW1A101M	ELECTRO	100UF	10WV
C18 ,19			CC73FCH1H560J	CHIP C	56PF	J
C20			CK73FB1H103K	CHIP C	0.010UF	K
C21			CK73FB1H183K	CHIP C	0.018UF	K
C22			CK73FB1H223K	CHIP C	0.022UF	K
C23 ,24			CK73FB1E104K	CHIP C	0.10UF	K
C25 ,26			CE04KW0J331M	ELECTRO	330UF	6.3WV
C27 ,28			CC73FSL1H151J	CHIP C	150PF	J
C29 ,30			CC73FSL1H821J	CHIP C	820PF	J
C31 ,32			CE04KW1A470M	ELECTRO	47UF	10WV
C33 ,34			CC73FSL1H821J	CHIP C	820PF	J
C35			CK73FB1H103K	CHIP C	0.010UF	K
C36 ,37			CK45FF1H103Z	CERAMIC	0.010UF	Z
C39			CE04KW1E222M	ELECTRO	2200UF	25WV
C40			CK73FB1H102K	CHIP C	1000PF	K
C41			CE04KW1A332M	ELECTRO	3300UF	10WV
C42			CK73FB1E104K	CHIP C	0.10UF	K
C44			CE04KW1A101M	ELECTRO	100UF	10WV
C45			CE04KW1C100M	ELECTRO	10UF	16WV
C46			CE04KW2A470M	ELECTRO	47UF	100WV
C47			CE04KW1H010M	ELECTRO	1.0UF	50WV
C48			CE04KW1H100M	ELECTRO	10UF	50WV
C49			CK73FB1H103K	CHIP C	0.010UF	K
C50			CE04KW1A221M	ELECTRO	220UF	10WV
C51			CE04KW0J331M	ELECTRO	330UF	6.3WV
C52			CE04KW1H010M	ELECTRO	1.0UF	50WV
C53			CE04KW1A101M	ELECTRO	100UF	10WV
C54			C90-3623-05	BACKUP	0.33F	5.5V
C55			CE04KW1H010M	ELECTRO	1.0UF	50WV
C56			CK73FB1H103K	CHIP C	0.010UF	K
C57 ,58			CC73FSL1H221J	CHIP C	220PF	J
C59			CK73FB1H103K	CHIP C	0.010UF	K
C64			CK73FB1H103K	CHIP C	0.010UF	K
C65 ,66			CE04KW1A470M	ELECTRO	47UF	10WV
C67 ,68			CK73FB1E104K	CHIP C	0.10UF	K
C71			CK73FB1H103K	CHIP C	0.010UF	K
C72			CE04RW0J470M	ELECTRO	47UF	6.3WV
C73			CK73FB1E104K	CHIP C	0.10UF	K
C87 ,88			CE04KW1A470M	ELECTRO	47UF	10WV
C91			CK73FB1H103K	CHIP C	0.010UF	K
C92			CC73FSL1H221J	CHIP C	220PF	J

L : Scandinavia K : USA P : Canada R : Mexico C : China I : Malaysia
 Y : PX(Far East,Hawaii) T : England E : Europe G : Germany V : China(Shanghai)
 Y : AAFES(Europe) X : Australia Q : Russia H : Korea M : Other Areas Δ indicates safety critical components.

* New Parts
 Parts without **Parts No.** are not supplied.
 Les articles non mentionnes dans le **Parts No.** ne sont pas fournis.
 Teile ohne **Parts No.** werden nicht geliefert.

4

Ref. No	Add-ress	New Parts	Parts No.	Description	Desti-nation	Re-marks
CN1			E40-4856-05	FLAT CABLE CONNECTOR		
CN2			E40-4979-05	PIN ASSY		
CN3			E40-3254-05	PIN ASSY		
CN4			E40-3252-05	PIN ASSY		
CN5			E40-3246-05	PIN ASSY		
CN6			E40-3241-05	PIN ASSY		
CN7			E40-4428-05	PIN ASSY		
CN8			E40-4245-05	PIN ASSY		
CN9 ,10			E40-4944-05	FLAT CABLE CONNECTOR		
J1			E63-1078-05	PIN JACK		
J2			E11-0293-05	MINIATURE PHONE JACK(2P)		
-			J19-6037-03	HOLDER		
E7			J11-0808-05	WIRE CLAMPER		
L1			L40-1001-17	SMALL FIXED INDUCTOR(10UH,K)		
L2			L33-0558-05	CHOKE COIL		
L5			L40-1001-17	SMALL FIXED INDUCTOR(10UH,K)		
X1		*	L77-2288-05	CRYSTAL RESONATOR(16.9344MHZ)		
X2			L78-0615-05	RESONATOR (12.5MHZ)		
X4			L78-0284-05	RESONATOR (5MHZ)		
CP1 ,2			R90-0875-05	MULTI-COMP 100KX15		
CP3			R90-0855-05	MULTI-COMP 100KX5	J	
R1			RK73FB2A224J	CHIP R	220K	J 1/10W
R6			RK73FB2A224J	CHIP R	220K	J 1/10W
R7			RK73FB2A100J	CHIP R	10	J 1/10W
R8			RK73FB2A273J	CHIP R	27K	J 1/10W
R9			RK73FB2A153J	CHIP R	15K	J 1/10W
R10 ,11			RK73FB2A101J	CHIP R	100	J 1/10W
R13			RK73FB2A473J	CHIP R	47K	J 1/10W
R14			RK73FB2A472J	CHIP R	4.7K	J 1/10W
R15 ,16			RK73FB2A103J	CHIP R	10K	J 1/10W
R17 ,18			RK73FB2A153J	CHIP R	15K	J 1/10W
R19			RK73FB2A104J	CHIP R	100K	J 1/10W
R20			RK73FB2A333J	CHIP R	33K	J 1/10W
R21			RK73FB2A104J	CHIP R	100K	J 1/10W
R22			RK73FB2A105J	CHIP R	1.0M	J 1/10W
R23			RK73FB2A103J	CHIP R	10K	J 1/10W
R24 ,25			RK73FB2A332J	CHIP R	3.3K	J 1/10W
R26			RK73FB2A331J	CHIP R	330	J 1/10W
R29			RK73FB2A473J	CHIP R	47K	J 1/10W
R30			RK73FB2A472J	CHIP R	4.7K	J 1/10W
R31			RK73FB2A364J	CHIP R	360K	J 1/10W
R32			RK73FB2A474J	CHIP R	470K	J 1/10W
R33			RK73FB2A912J	CHIP R	9.1K	J 1/10W
R34			RK73FB2A473J	CHIP R	47K	J 1/10W
R37 -42			RK73FB2A103J	CHIP R	10K	J 1/10W
R43 ,44			RK73FB2A273J	CHIP R	27K	J 1/10W
R45 ,46			RK73FB2A683J	CHIP R	68K	J 1/10W
R49 ,50		*	R92-1937-05	CHIP R	41.2K	F 1/10W
R51 ,52		*	R92-1938-05	CHIP R	10K	F 1/10W
R53 ,54			RK73FB2A103J	CHIP R	10K	J 1/10W
R55 ,56			RK73FB2A104J	CHIP R	100K	J 1/10W

L : Scandinavia K : USA P : Canada R : Mexico C : China I : Malaysia
 Y : PX(Far East,Hawaii) T : England E : Europe G : Germany V : China(Shanghai)
 Y : AAFES(Europe) X : Australia Q : Russia H : Korea M : Other Areas Δ indicates safety critical components.

CD-423M/423M-S/424M/DPF-J3030/J5030
 PARTS LIST

* New Parts

Parts without **Parts No.** are not supplied.Les articles non mentionnés dans le **Parts No.** ne sont pas fournis.Teile ohne **Parts No.** werden nicht geliefert.

5

Ref. No	Add-ress	New Parts	Parts No.	Description	Desti-nation	Re-marks
R57 ,58			RK73FB2A561J	CHIP R 560 J 1/10W		
R59 ,60			RK73FB2A331J	CHIP R 330 J 1/10W		
R61 ,62			RK73FB2A222J	CHIP R 2.2K J 1/10W		
R63 ,64			RK73FB2A102J	CHIP R 1.0K J 1/10W		
R65			RK73FB2A361J	CHIP R 360 J 1/10W		
R68 ,69			RK73FB2A103J	CHIP R 10K J 1/10W		
R70			RK73FB2A472J	CHIP R 4.7K J 1/10W		
R71			RK73FB2A473J	CHIP R 47K J 1/10W		
R72			RK73FB2A101J	CHIP R 100 J 1/10W		
R73			RK73FB2A134J	CHIP R 130K J 1/10W		
R74			RK73FB2A103J	CHIP R 10K J 1/10W		
R75			RK73FB2A223J	CHIP R 22K J 1/10W		
R76			RK73FB2A105J	CHIP R 1.0M J 1/10W		
R77 ,78			RK73FB2A101J	CHIP R 100 J 1/10W		
R79 ,80			RK73FB2A153J	CHIP R 15K J 1/10W		
R81			RK73FB2A472J	CHIP R 4.7K J 1/10W		
R82			RK73FB2A271J	CHIP R 270 J 1/10W		
R83			RK73FB2A512J	CHIP R 5.1K J 1/10W		
R84			RK73FB2A223J	CHIP R 22K J 1/10W		
R85			RK73FB2A224J	CHIP R 220K J 1/10W		
R86			RK73FB2A164J	CHIP R 160K J 1/10W		
R87			RK73FB2A153J	CHIP R 15K J 1/10W		
R88			RK73FB2A103J	CHIP R 10K J 1/10W		
R89 ,90			RK73FB2A331J	CHIP R 330 J 1/10W		
R91 -94			RK73FB2A104J	CHIP R 100K J 1/10W		
R100,101			RK73FB2A473J	CHIP R 47K J 1/10W		
R102			RK73FB2A224J	CHIP R 220K J 1/10W		
R103-105			RK73FB2A473J	CHIP R 47K J 1/10W		
R106,107			RK73FB2A472J	CHIP R 4.7K J 1/10W		
R108-110			RK73FB2A473J	CHIP R 47K J 1/10W		
R114,115			RK73FB2A473J	CHIP R 47K J 1/10W		
R116			RK73FB2A332J	CHIP R 3.3K J 1/10W		
R117			RK73FB2A103J	CHIP R 10K J 1/10W		
R118			RK73FB2A104J	CHIP R 100K J 1/10W		
R119			RK73FB2A473J	CHIP R 47K J 1/10W		
R120,121			RK73FB2A103J	CHIP R 10K J 1/10W		
R122,123			RK73FB2A512J	CHIP R 5.1K J 1/10W		
R124,125			RK73FB2A302J	CHIP R 3.0K J 1/10W		
R126,127			RK73FB2A202J	CHIP R 2.0K J 1/10W		
R149			RK73FB2A331J	CHIP R 330 J 1/10W		
R156			RK73FB2A472J	CHIP R 4.7K J 1/10W		
R157			RK73FB2A473J	CHIP R 47K J 1/10W		
VR1			R12-3101-05	TRIMMING POT.(22K)		
S1 -9			S70-0031-05	TACT SWITCH		
S11			S64-0034-05	LEVER SWITCH		
S12			S62-0070-05	SLIDE SWITCH		
S13			S31-2131-05	SLIDE SWITCH (POWER TYPE)	Y1	
S10			T99-0596-05	ROTARY ENCODER		
D1 ,2			HSS104	DIODE		
D1 ,2			1SS133	DIODE		
D3			D3SBA20F03	DIODE		
D3			RBV-402LFA	DIODE		
D4			MTZJ7.5(B)	ZENER DIODE		

L : Scandinavia K : USA P : Canada R : Mexico C : China I : Malaysia
 Y : PX(Far East,Hawaii) T : England E : Europe G : Germany V : China(Shanghai)
 Y : AAFES(Europe) X : Australia Q : Russia H : Korea M : Other Areas Δ indicates safety critical components .

* New Parts

Parts without **Parts No.** are not supplied.Les articles non mentionnés dans le **Parts No.** ne sont pas fournis.Teile ohne **Parts No.** werden nicht geliefert.

6

Ref. No	Add-ress	New Parts	Parts No.	Description	Desti-nation	Re-marks
D4			RD7.5JS(B2)	ZENER DIODE		
D5			DLM10C	DIODE		
D6			HSS104	DIODE		
D6			1SS133	DIODE		
Δ D7 ,8			S5688B(TPB5)	DIODE		
D9			MTZJ11(B)	ZENER DIODE		
D9			RD11ES(B2)	ZENER DIODE		
D10			HSS104	DIODE		
D10			1SS133	DIODE		
Δ D11 ,12			S5688B(TPB5)	DIODE		
D13 -21			HSS104	DIODE		
D13 -21			1SS133	DIODE		
ED1		*	16-MT-66GNK	FLUORESCENT INDICATOR TUBE		
IC1		*	CXA1821M	ANALOGUE IC		
IC2		*	CXD2587Q*	MOS-IC		
IC3			NJM2115M	ANALOGUE IC		
IC4			BA17805T	ANALOGUE IC		
IC4			UPC7805AHF	ANALOGUE IC		
IC5			BA5979S	ANALOGUE IC		
IC6		*	UPD784214GF533	MI-COM IC		
IC7			NJM2100M	IC(OP AMPLIFIER)		
IC9			CY62256LL-70	MEMORY IC		
IC9			W24258S-70LE	MEMORY IC		
IC11			TA8409S	MOS-IC		
IC12			LB1930M	ANALOGUE IC		
IC13		*	UPD780232GC012	MI-COM IC		
IC14			PST993D-T	ANALOGUE IC		
Q1			2SA954(L,K)	TRANSISTOR		
Q3 ,4			DTC124ESA	DIGITAL TRANSISTOR		
Q3 ,4			UN4212	DIGITAL TRANSISTOR		
Q5 ,6			DTA143TSA	DIGITAL TRANSISTOR		
Q5 ,6			UN4116	DIGITAL TRANSISTOR		
Q7 ,8			2SD1450(S,T)	TRANSISTOR		
Q9			2SK246(Y)	FET		
Q10			2SB1165(R,S)	TRANSISTOR		
Q11			2SC2458(Y,GR)	TRANSISTOR		
Q11			2SC2785(F,E)	TRANSISTOR		
Q12			DTC124ESA	DIGITAL TRANSISTOR		
Q12			UN4212	DIGITAL TRANSISTOR		
Δ Q14			2SA954(L,K)	TRANSISTOR		
Q15			2SA1048(Y,GR)	TRANSISTOR		
Q15			2SA1175(F,E)	TRANSISTOR		
Q16 ,17			2SD1450(S,T)	TRANSISTOR		
Q18			DTA113ZSA	DIGITAL TRANSISTOR		
Q18			UN4119	DIGITAL TRANSISTOR		
Δ Q19			2SB1417(Q,P)	TRANSISTOR		
Δ Q19			2SB1640	TRANSISTOR		
Q20			2SC2458(Y,GR)	TRANSISTOR		
Q20			2SC2785(F,E)	TRANSISTOR		
Δ Q23			DTA124ESA	DIGITAL TRANSISTOR		
Q23			UN4112	DIGITAL TRANSISTOR		
Q24 ,25			DTC124ESA	DIGITAL TRANSISTOR		
Q24 ,25			UN4212	DIGITAL TRANSISTOR		
Q26			DTA113ZSA	DIGITAL TRANSISTOR		
Q26			UN4119	DIGITAL TRANSISTOR		

L : Scandinavia K : USA P : Canada R : Mexico C : China I : Malaysia
 Y : PX(Far East,Hawaii) T : England E : Europe G : Germany V : China(Shanghai)
 Y : AAFES(Europe) X : Australia Q : Russia H : Korea M : Other Areas Δ indicates safety critical components .

CD-423M/423M-S/424M/DPF-J3030/J5030
PARTS LIST

* New Parts
Parts without **Parts No.** are not supplied.
Les articles non mentionnés dans le **Parts No.** ne sont pas fournis.
Teile ohne **Parts No.** werden nicht geliefert.

7

Ref. No	Add-ress	New Parts	Parts No.	Description	Desti-nation	Re-marks
A1			W02-2561-05	ELECTRIC CIRCUIT MODULE		
A2			W02-1114-15	OSCILLATING MODULE		
MECHANISM CHANGER (MG-CH1)						
1	1D		A11-1134-08	BASE ARM		
2	1D		D10-3788-08	LEVER R		
3	1D		D12-0158-08	CAM CHANGE		
4	1D		J19-5892-08	HOLDER ARM		
5	1D		G16-0912-08	RUBBER		
6	1D		D10-3778-08	ARM DISC		
7	1D		G01-4060-08	SPG DISC H		
8	1D		J21-6576-08	PLATE ARM		
9	1D		D10-3785-08	SLIDER RACK		
10	1D		J19-5891-08	HOLDER RACK		
12	1D		D10-3787-08	LEVER CHANGE		
14	1D,2D		T42-0920-08	MOTOR		
17	1C		D13-1856-08	GEAR D		
19	2C		D10-3781-08	LEVER HOOK A		
20	2D		D10-3782-08	LEVER HOOK B		
21	2C		D13-1857-08	GEAR E		
22	2C		S64-0038-08	LEVER SW		
25	2D		J21-6579-08	PLATE LIMITER		
26	2D		D10-3779-18	ARM SWING		
27	2D	*	D13-1855-18	GEAR CAM		
29	2C		J21-6573-08	PLATE LOCK		
30	2C		G01-4061-08	SPG LOCK LEVER		
31	2D		D10-3780-18	SLIDER CAM		
32	2D		J21-6574-08	PLATE SLIDE		
33	2D		D13-1854-08	GEAR SLIDER		
34	2D		D10-3786-18	LEVER STOPPER		
37	2D		J90-0854-08	GUIDE RACK		
38	1D		G01-4064-08	SPG CHANGE		
39	2E		D21-1899-08	PIN ROLLER		
40	1D		D14-0393-08	HOLDER ROLLER		
41	2E		J19-5888-08	ROLLER GUIDE		
42	2E	*	D21-1900-18	SHAFT MAIN		
43	2E		J19-5890-08	HOLDER SHAFT		
44	2E		J90-0856-08	GUIDE DISC		
45	1E		D32-0354-08	STOPPER DISC		
46	1E		J19-5893-08	HOLDER SENSOR		
47	1E		J19-5927-08	HOLDER SENSOR		
49	1D		J21-6570-08	PLATE HOLD T		
55	2D	*	J21-6580-18	PLATE LINK		
58	2D		J21-6571-08	PLATE SLIDER A		
60	1E		J21-6575-08	PLATE SUPPORT B		
62	2D		D13-1852-08	GEAR B		
63	2D		D13-1853-08	GEAR C		
64	1E		J90-0855-08	GUIDE DISC U		
65	1D		J19-5894-08	HOLDER DISC U		
67	2D		G01-4057-08	SPG SLIDER		
69	1D		G01-4062-08	SPG DAMPER A		
70	1D		G01-4063-08	SPG DAMPER B		
72	2D		G01-4065-08	SPG STOPPER		
73	1E		J19-5889-08	STOCKER ROTARY		
80	1D		J11-0840-08	CLAMPER		

L : Scandinavia K : USA P : Canada R : Mexico C : China I : Malaysia
Y : PX(Far East,Hawaii) T : England E : Europe G : Germany V : China(Shanghai)
Y : AAFES(Europe) X : Australia Q : Russia H : Korea M : Other Areas Δ indicates safety critical components .

* New Parts
Parts without **Parts No.** are not supplied.
Les articles non mentionnés dans le **Parts No.** ne sont pas fournis.
Teile ohne **Parts No.** werden nicht geliefert.

8

Ref. No	Add-ress	New Parts	Parts No.	Description	Desti-nation	Re-marks
82	1D,1E		J02-1412-08	INSULATOR		
83	1E		E40-8285-08	CONNECTOR 5P		
86	1D		T99-0565-05	MAGNET		
87	1E		N29-0287-08	E-RING 6.0		
89	2E		N19-1460-08	PSW 8.5X30X0.5		
90	1D		J69-0083-04	DOUBLE COATED TAPE		
91	2E		T95-0160-08	PHOTO INTERRUPTER		
92	2E		E40-8284-08	CONNECTOR 5P		
94	1D,1E		N19-1461-08	FLAT WASHER		
101	2D		D32-0360-08	PLATE STOPPER		
102	1D		G16-0936-08	SHEET		
LED			SIM-20ST	LED		
TR			RPM-20PB	TRANSISTOR		
R			RK73FB2A471J	CHIP R	470	J 1/10W
MECHANISM ASSY (D40-1515-05)						
3	2A		D10-3606-08	ROD		
4	1B		D13-1720-08	GEAR		
6	3B		S74-0038-08	LEAF SWITCH		
8	3B		E40-3264-05	PIN ASSY		
DM	1B		A11-1082-18	SUB CHASSIS ASSY		
FM	2B		T42-0817-08	MOTOR ASSY		
PU	1A		T25-0061-08	OPTICAL PICKUP HEAD		

L : Scandinavia K : USA P : Canada R : Mexico C : China I : Malaysia
Y : PX(Far East,Hawaii) T : England E : Europe G : Germany V : China(Shanghai)
Y : AAFES(Europe) X : Australia Q : Russia H : Korea M : Other Areas Δ indicates safety critical components .

HOW TO READ THE PARTS LIST

ABBREVIATION OF MODEL AND MASS PRODUCTION'S DESTINATIONS

MODEL	ABB.	Australia	Canada	China	England	Europe	Germany	Korea	Malaysia
CD-423M	-	-	P1	-	-	-	-	-	-
CD-423M-S	-	-	-	-	-	-	-	-	-
CD-424M	-	-	P2	-	-	-	-	-	-
DPF-J3030	-	-	-	-	T1	E1	-	-	-
DPF-J5030	-	-	-	-	-	-	-	-	-
MODEL	ABB.	Mexico	PX/AAFES	Russia	Scandinavia	Shanghai	USA	Other area	
CD-423M	-	-	-	-	-	-	K	-	-
CD-423M-S	-	-	-	-	-	-	K1	-	-
CD-424M	-	-	-	-	-	-	K2	-	-
DPF-J3030	-	-	-	-	-	-	-	-	-
DPF-J5030	-	-	Y1	-	-	-	-	-	-

PARTS DESCRIPTIONS

CAPACITORS

CC 45 TH 1H 220 J
 1 2 3 4 5 6

- 1 = Type ... ceramic, electrolytic, etc.
- 2 = Shape ... round, square, ect.
- 3 = Temp. coefficient
- 4 = Voltage rating
- 5 = Value
- 6 = Tolerance

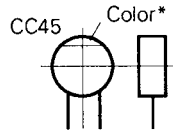

Capacitor value

- 010 = 1pF
- 100 = 10pF
- 101 = 100pF
- 102 = 1000pF = 0.001μF
- 103 = 0.01μF

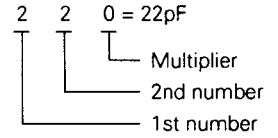

Temperature coefficient

1st Word	C	L	P	R	S	T	U
Color*	Black	Red	Orange	Yellow	Green	Blue	Violet
ppm/°C	0	-80	-150	-220	-330	-470	-750

2nd Word	G	H	J	K	L
ppm/°C	±30	±60	±120	±250	±500

Example : CC45TH = -470 ± 60ppm/°C

Tolerance (More than 10pF)

Code	C	D	G	J	K	M	X	Z	P	No code
(%)	±0.25	±0.5	±2	±5	±10	±20	+40 -20	+80 -20	+100 -0	More than 10μF -10 ~ +50 Less than 4.7μF -10 ~ +75

(Less than 10pF)

Code	B	C	D	F	G
(pF)	±0.1	±0.25	±0.5	±1	±2

Voltage rating

2nd word \ 1st word	A	B	C	D	E	F	G	H	J	K	V
0	1.0	1.25	1.6	2.0	2.5	3.15	4.0	5.0	6.3	8.0	-
1	10	12.5	16	20	25	31.5	40	50	63	80	35
2	100	125	160	200	250	315	400	500	630	800	-
3	1000	1250	1600	2000	2500	3150	4000	5000	6300	8000	-

Chip capacitors

(EX) C C 7 3 F S L 1 H 0 0 0 J
 1 2 3 4 5 6 7

(Chip) (CH, RH, UJ, SL)

(EX) C K 7 3 F F 1 H 0 0 0 Z
 1 2 3 4 5 6 7

(Chip) (B, F)

Refer to the table above.

- 1 = Type
- 2 = Shape
- 3 = Dimension
- 4 = Temp. coefficient
- 5 = Voltage rating
- 6 = Value
- 7 = Tolerance

Dimension (Chip capacitors)

Dimension code	L	W	T
Empty	5.6 ± 0.5	5.0 ± 0.5	Less than 2.0
A	4.5 ± 0.5	3.2 ± 0.4	Less than 2.0
B	4.5 ± 0.5	2.0 ± 0.3	Less than 2.0
C	4.5 ± 0.5	1.25 ± 0.2	Less than 1.25
D	3.2 ± 0.4	2.5 ± 0.3	Less than 1.5
E	3.2 ± 0.2	1.6 ± 0.2	Less than 1.25
F	2.0 ± 0.3	1.25 ± 0.2	Less than 1.25
G	1.6 ± 0.2	0.8 ± 0.2	Less than 1.0

RESISTORS

Chip resistor (Carbon)

(EX) R K 7 3 E B 2 B 0 0 0 J
 1 2 3 4 5 6 7

(Chip) (B, F)

Carbon resistor (Normal type)

(EX) R D 1 4 B B 2 C 0 0 0 J
 1 2 3 4 5 6 7

- 1 = Type
- 2 = Shape
- 3 = Dimension
- 4 = Temp. coefficient
- 5 = Rating wattage
- 6 = Value
- 7 = Tolerance

Dimension

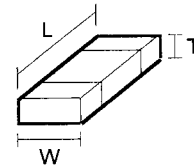

Dimension (Chip resistor)

Dimension code	L	W	T
E	3.2 ± 0.2	1.6 ± 0.2	1.0
F	2.0 ± 0.3	1.25 ± 0.2	1.0
G	1.6 ± 0.2	0.8 ± 0.2	0.5 ± 0.1

Rating wattage

Code	Wattage	Code	Wattage	Code	Wattage
1J	1/16W	2C	1/6W	3A	1W
2A	1/10W	2E	1/4W	3D	2W
2B	1/8W	2H	1/2W		

CD-423M/423M-S/424M/DPF-J3030/J5030

SPECIFICATIONS

[Format]

System Compact disc digital audio system
Laser Semiconductor laser

[D/A Convertors]

D/A Conversion 1 Bit
Oversampling 8 fs (352.8 kHz)

[Audio]

Frequency response 4 Hz ~ 20 kHz, ± 0.5 dB
Signal to noise ratio More than 103 dB
Dynamic range More than 95 dB
Total harmonic distortion + noise
..... Less than 0.005% (at 1 kHz)
Channel separation More than 95 dB (at 1 kHz)
Wow & flutter Unmeasurable Limit
Output level/impedance
Fixed 2.0 V/1 k Ω
Digital output
Optical -15 dBm ~ -21 dBm (Wave length 660 nm)

[Laser]

Wave length 760 nm - 800 nm
Laser power class Class 1 (IEC)

[General]

Power consumption 10 W
Dimensions
W : 440 mm (17-5/16")
H : 163 mm (6-13/16")
D : 479 mm (18-7/8")
Weight (Net) 7 kg (15.4 lb)



1. KENWOOD follows a policy of continuous advancements in development. For this reason specifications may be changed without notice.
2. The full performance may not be exhibited in an extremely cold location (under a water-freezing temperature).

Note:

Component and circuit are subject to modification to insure best operation under differing local conditions. This manual is based on Europe (E) standard, and provides information on regional circuit modification through use of alternate schematic diagrams, and information on regional component variations through use of parts list.

KENWOOD CORPORATION

14-6, Dogenzaka 1-chome, Shibuya-ku, Tokyo, 150-8501 Japan

KENWOOD SERVICE CORPORATION

P.O. BOX 22745, 2201 East Dominguez St., Long Beach, CA 90801-5745, U.S.A.

KENWOOD ELECTRONICS CANADA INC.

6070 Kestrel Road, Mississauga, Ontario, Canada L5T 1S8

KENWOOD ELECTRONICS LATIN AMERICA S.A.

P.O. BOX 55-2791, Piso 6 plaza Chase, Cl. 47 y Aquilino de la Guardia Panama, Republic de Panama

KENWOOD ELECTRONICS BRASIL LTDA.

Av. Moema, 170-17, Andar-Cobertura "B", Ed. Maximum Service Center, 04077-020 Moema, São Paulo-SP-Brasil

KENWOOD ELECTRONICS U.K. LIMITED

KENWOOD House, Dwight Road, Watford, Herts., WD1 8EB., United Kingdom

KENWOOD ELECTRONICS BELGIUM N.V.

Meachelsesteenweg 418, B-1930 Zaventem, Belgium

KENWOOD ELECTRONICS DEUTSCHLAND GMBH

Rembrücker Str. 15, 63150 Heusenstamm, Germany

KENWOOD ELECTRONICS FRANCE S.A.

13 Boulevard Ney, 75018 Paris, France

KENWOOD ELECTRONICS ITALIA S.p.A.

Via G. Sirtori, 7/9 20129, Milano, Italy

KENWOOD IBÉRICA S.A.

Bolivia, 239-08020 Barcelona, Spain

KENWOOD ELECTRONICS AUSTRALIA PTY. LTD.

(A.C.N. 001 499 074)
16 Giffnock Avenue, North Ryde, N.S.W. 2113, Australia

KENWOOD ELECTRONICS (HONG KONG) LTD.

Unit 3712-3724, Level 37, Tower 1, Metroplaza, 223 Hing Fong Road, Kwai Fong N.T., Hong Kong

KENWOOD ELECTRONICS GULF FZE

P.O.Box 61318, Jebel Ali, Dubai, U.A.E.

KENWOOD ELECTRONICS SINGAPORE PTE LTD.

No. 1 Genting Lane #02-02, KENWOOD Building, Singapore, 349544

KENWOOD ELECTRONICS (MALAYSIA) SDN BHD.

#4.01 Level 4, Wisma Academy Lot 4A, Jalan 19/1 46300 Petaling Jaya Selangor Darul Ehsan Malaysia

KENWOOD ELECTRONICS (THAILAND) CO., LTD.

2019 New Pechburi Road, Bangkapi, Huaykwang, Bangkok, 10320 Thailand